

# Product datasheet

Specifications



circuit breaker, EasyPact  
CVS250F, 36kA at 415VAC, 250A,  
TM-D trip unit, 3P3d

LV525333

! Discontinued on: 28 July 2017

! Discontinued

## Main

Range	EasyPact
Range of product	EasyPact CVS100...250
Product name	EasyPact CVS
Device short name	CVS250F
Product or component type	Circuit breaker
Device application	Distribution
Poles description	3P
Protected poles description	3D
Earth leakage protection (Vigi add on)	Without
[In] rated current	250 A at 40 °C
Network type	AC
Utilisation category	Category A
[Icu] Breaking capacity	36 kA Icu at 440 V AC 50/60 Hz conforming to IEC 60947-2 36 kA Icu at 380/415 V AC 50/60 Hz conforming to IEC 60947-2 70 kA Icu at 220/240 V AC 50/60 Hz conforming to IEC 60947-2
Trip unit name	TM-D
Trip unit technology	Thermal-magnetic
Trip unit rating	250 A at 40 °C
Protection type	Overload protection (thermal) Short-circuit protection (magnetic)

## Complementary

[Uimp] rated impulse withstand voltage	8 kV conforming to EN/IEC 60947-2
Network frequency	50/60 Hz
Breaking capacity code	F
[Ics] rated service breaking capacity	18 kA at 440 V AC 50/60 Hz conforming to IEC 60947-2 36 kA at 380/415 V AC 50/60 Hz conforming to IEC 60947-2 70 kA at 220/240 V AC 50/60 Hz conforming to IEC 60947-2
Mechanical durability	20000 cycles
Electrical durability	10000 cycles 415 V In conforming to IEC 60947-2
Control type	Toggle
Thermal protection adjustment range	175...250 A

Long time pick-up adjustment type Ir	Adjustable
Long time pick-up adjustment range	0.7...1 x In
Long time delay adjustment type	Fixed
Instantaneous pick-up adjustment type Ii	Fixed
Instantaneous pick-up adjustment range	2500 A
Contact position indicator	Yes
Mounting support	Backplate
Mounting mode	Fixed
Upside connection	Front
Downside connection	Front
Connections - terminals	Screw connection
Connection pitch	35 mm
Compatibility code	CVS250
Width	105 mm
Depth	86 mm
Height	161 mm
Net weight	1.7 kg

## Environment

Standards	EN 60947-2 IEC 60947-2
Product certifications	IEC GOST
Electrical shock protection class	Class II
Pollution degree	3 conforming to IEC 60664-1
IP degree of protection	IP40
Ambient air temperature for operation	-25...70 °C
Ambient air temperature for storage	-50...85 °C

## Packing Units

Unit Type of Package 1	PCE
Number of Units in Package 1	1
Package 1 Height	11.000 cm
Package 1 Width	14.000 cm
Package 1 Length	19.000 cm
Package 1 Weight	1.935 kg
Unit Type of Package 2	S03
Number of Units in Package 2	8
Package 2 Height	30.000 cm
Package 2 Width	30.000 cm
Package 2 Length	40.000 cm

<b>Package 2 Weight</b>	15.795 kg
<b>Unit Type of Package 3</b>	P12
<b>Number of Units in Package 3</b>	64
<b>Package 3 Height</b>	45.000 cm
<b>Package 3 Width</b>	80.000 cm
<b>Package 3 Length</b>	120.000 cm
<b>Package 3 Weight</b>	135.360 kg

## Sustainability

**Green Premium™ label** is Schneider Electric's commitment to delivering products with best-in-class environmental performance. Green Premium promises compliance with the latest regulations, transparency on environmental impacts, as well as circular and low-CO<sub>2</sub> products.

**Guide to assessing product sustainability** is a white paper that clarifies global eco-label standards and how to interpret environmental declarations.

[Learn more about Green Premium >](#)

[Guide to assess a product's sustainability >](#)



Transparency RoHS/REACH

## Well-being performance

Mercury Free

Rohs Exemption Information Yes

## Certifications & Standards

Reach Regulation [REACH Declaration](#)

Eu Rohs Directive Compliant with Exemptions

China Rohs Regulation [China RoHS declaration](#)  
Product out of China RoHS scope. Substance declaration for your information

Environmental Disclosure [Product Environmental Profile](#)

Weee The product must be disposed on European Union markets following specific waste collection and never end up in rubbish bins

Circularity Profile [End of Life Information](#)

Dimensions Drawings

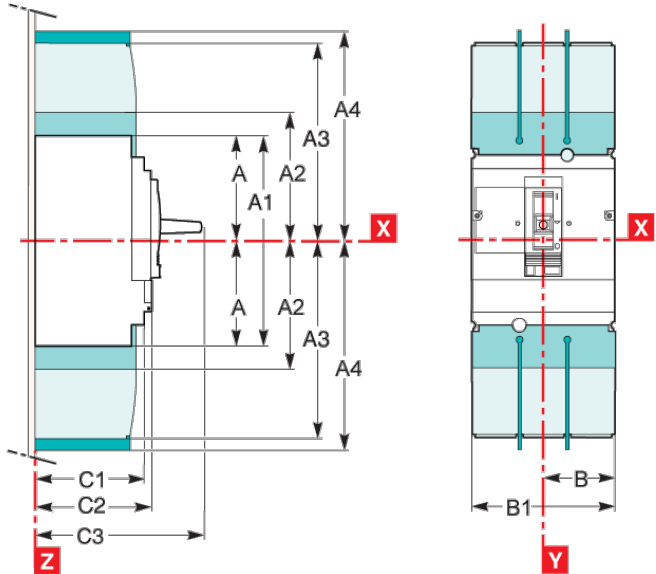
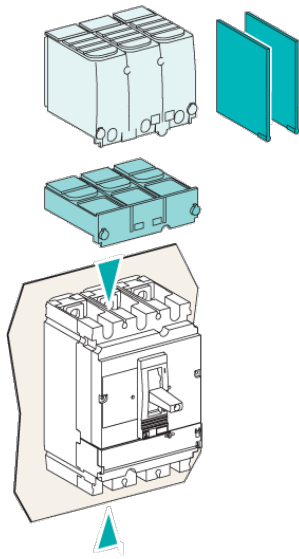

Type	A	A1	A2	A3	A4	A5	A6	A7	A8	A9	B	B1	B2	C1	C2	C3	E1
CVS100/160/250	80.5	161	94	145	178.5	155.5	236	169	220	253.5	52.5	105	140	81	86	111 <sup>(2)</sup>	62.5
CVS400/630	127.5	255	142.5	200	237	227.5	355	242.5	300	337	70	140	185	95.5	110	168	100
Type	E2	E3	E4	E5	E6	E7	E8	F1	F2	F3	G1	G2	G3	G4	G5	ØT	U
CVS100/160/250	125	70	140	137.5	200	145	215	35	17.5	70	95	75	13.5	23	17.5	24	y 32
CVS400/630	200	113.5	227	200	300	213.5	327	45	22.5	90	-	-	-	-	-	32	y 35

(2) C3=126mm for EasyPact CVS250B/F.

Assembly

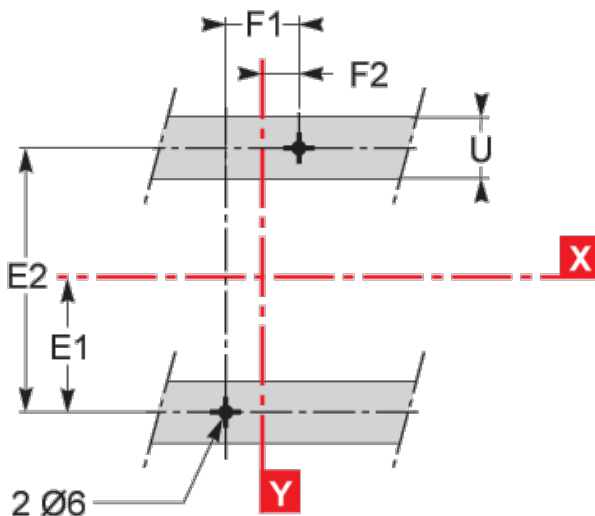
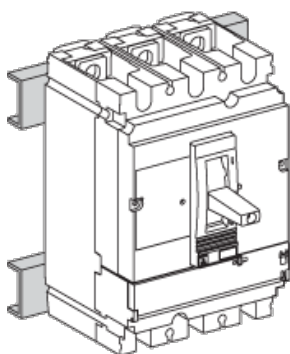
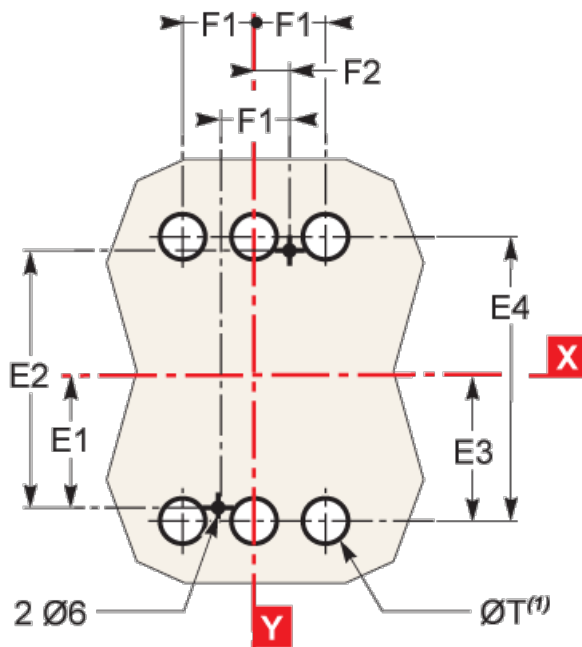
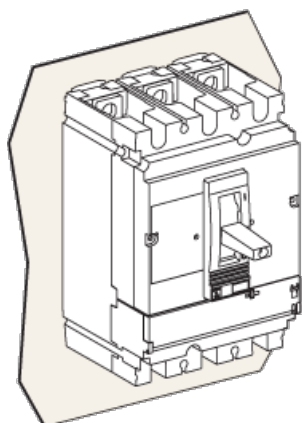

Type	A	A1	A2	A3	A4	A5	A6	A7	A8	A9	B	B1	B2	C1	C2	C3	E1
CVS100/160/250	80.5	161	94	145	178.5	155.5	236	169	220	253.5	52.5	105	140	81	86	111 <sup>(2)</sup>	62.5
CVS400/630	127.5	255	142.5	200	237	227.5	355	242.5	300	337	70	140	185	95.5	110	168	100
Type	E2	E3	E4	E5	E6	E7	E8	F1	F2	F3	G1	G2	G3	G4	G5	ØT	U
CVS100/160/250	125	70	140	137.5	200	145	215	35	17.5	70	95	75	13.5	23	17.5	24	y 32
CVS400/630	200	113.5	227	200	300	213.5	327	45	22.5	90	-	-	-	-	-	32	y 35

(2) C3=126mm for EasyPact CVS250B/F.

Performance Curves

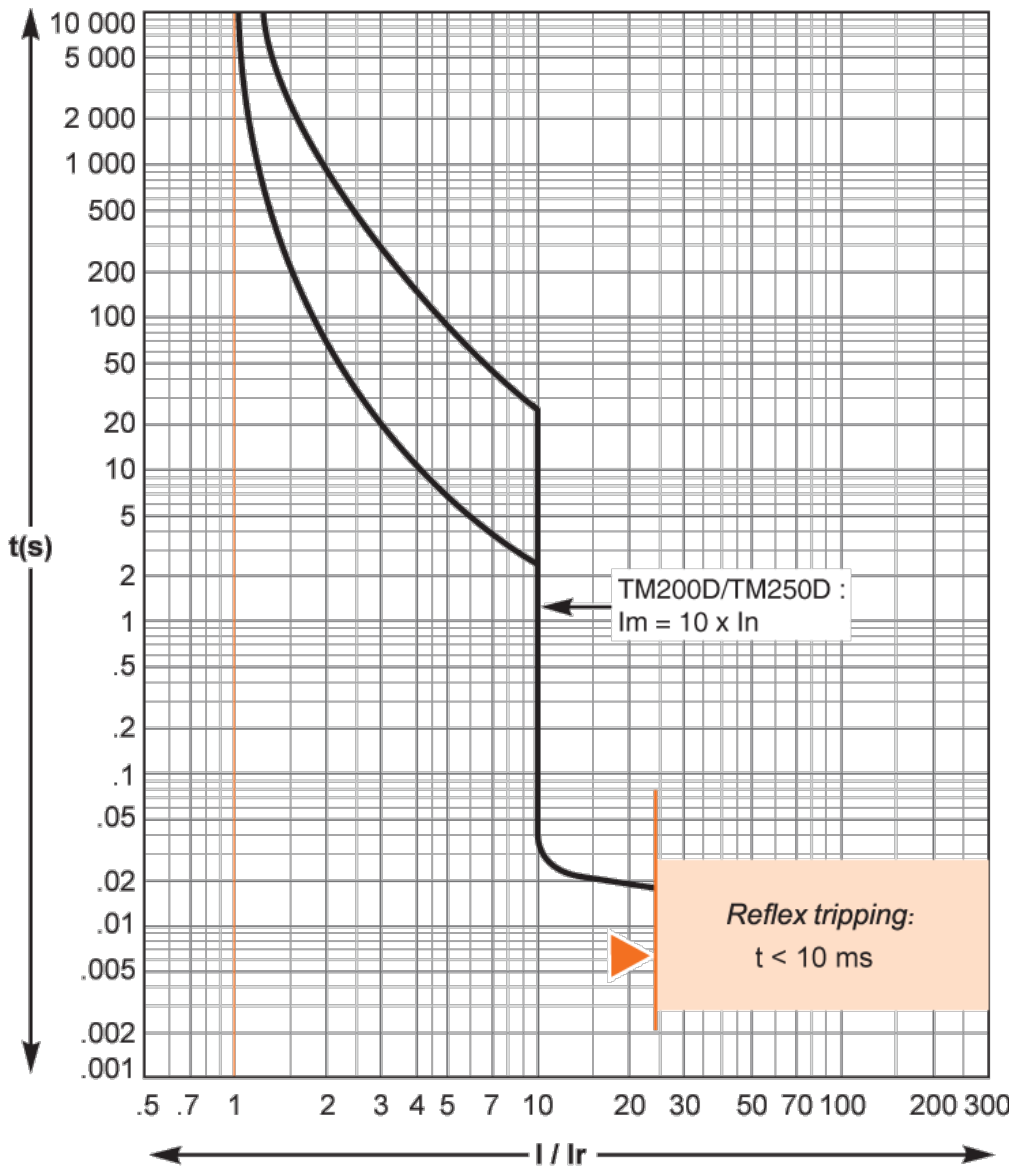

Offer Marketing Illustration

Product benefits / Features

---





Offer Marketing Illustration

Product benefits / Features

---



**EasyPact CVS**  
Technical Benefits

- MCCB with adjustable setting, rated from 16 to 630A in 3 standard sizes
- Breaking capacity from 25 to 50kA at 400/415 V, 3 and 4 pole versions
- Vast range of protection options, thermal-magnetic, electronic and earth leakage
- Deliver a high level of performance and cost-saving functionality
- Coordinated with selectivity and cascading for ACBs, MCCBs, MCBs

Offer Marketing Illustration

Product benefits / Features

---

## EasyPact CVS

### Moulded Case Circuit Breaker



A detailed illustration of the EasyPact CVS Moulded Case Circuit Breaker, showing its grey metal casing, a central handle, and various terminals and labels on the front panel.

- 

**Safe**  
Unlock unparalleled safety and control with our wire's unique ability to safely isolate and replace auxiliaries, even with an energized circuit breaker.
- 

**Reliable**  
It meets IEC 60947-2 standards for quality, high endurance, and fault current limitation technology, providing superior safety and protection.
- 

**Simple**  
Effortless retrofitting and seamless upgrades for enhanced flexibility and performance.